

6FM33D-X 12V 31.4Ah(10hr)

The rechargeable batteries are lead-lead dioxide systems. The dilute sulfuric acid electrolyte is absorbed by separators and plates and thus immobilized. Should the battery be accidentally overcharged producing hydrogen and oxygen, special one-way valves allow the gases to escape thus avoiding excessive pressure build-up. Otherwise, the battery is completely sealed and is, therefore, maintenance-free, leak proof and usable in any position.



Battery Construction

Component	Positive plate	Negative plate	Container	Cover	Safety valve	Terminal	Separator	Electrolyte
Raw material	Lead dioxide	Lead	ABS	ABS	Rubber	Pb	Fiberglass	Sulfuric acid

General Features

- Absorbent Glass Mat (AGM) technology for efficient gas recombination of up to 99% and freedom from electrolyte maintenance or water adding.
- Not restricted for air transport-complies with IATA/ICAO Special Provision A67.
- UL-recognized component.
- Can be mounted in any orientation.
- Computer designed lead, calcium tin alloy grid for high power density.
- Long service life, float or cyclic applications.
- Maintenance-free operation.
- Low self discharge.

Dimensions and Weight

Length(mm / inch)	195 / 7.68
Width(mm / inch)	130 / 5.12
Height(mm / inch)	155 / 6.10
Total Height(mm / inch)	168 / 6.61
Approx. Weight(Kg / lbs)	10.2 / 22.5

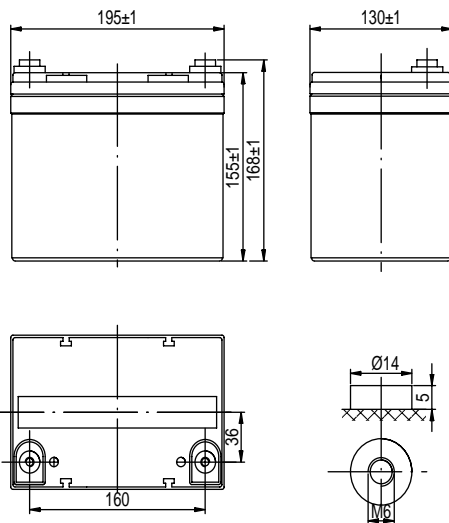

Performance Characteristics

Nominal Voltage	12V
Number of cell	6
Design Life	10 years
Nominal Capacity 77°F(25°C)	
10 hour rate (3.14A, 10.8V)	31.4Ah
5 hour rate (5.55A, 10.5V)	27.75Ah
1 hour rate (22.0A, 9.6V)	22.0Ah
Internal Resistance	
Fully Charged battery 77°F(25°C)	10mOhms
Self-Discharge	
3% of capacity declined per month at 20°C(average)	
Operating Temperature Range	
Discharge	-20~60°C
Charge	-10~60°C
Storage	-20~60°C
Max. Discharge Current 77°F(25°C)	330A(5s)
Short Circuit Current	850A
Charge Methods: Constant Voltage Charge 77°F(25°C)	
Cycle use	14.4-14.7V
Maximum charging current	9.9A
Temperature compensation	-30mV/°C
Standby use	13.6-13.8V
Temperature compensation	-20mV/°C

Discharge Constant Current (Amperes at 77°F25°C)

End Point Volts/Cell	5min	10min	15min	30min	45min	1h	3h	5h	10h
1.60V	109	77.0	59.7	36.1	26.4	22.0	8.99	6.27	3.28
1.65V	101	74.2	57.6	35.4	26.4	21.6	8.88	6.22	3.25
1.70V	94.1	70.1	52.9	32.4	24.7	20.9	8.37	6.12	3.22
1.75V	83.4	66.2	50.4	32.0	24.0	20.0	8.17	5.55	3.18
1.80V	75.5	57.6	48.0	31.1	23.3	19.5	8.10	5.47	3.14

Discharge Constant Power (Watts at 77°F25°C)

End Point Volts/Cell	5min	10min	15min	30min	45min	1h	2h	3h	5h
1.60V	204	144	114	70.6	52.7	40.3	23.0	17.2	12.1
1.65V	197	139	107	67.6	52.1	39.9	22.8	17.1	11.8
1.70V	176	131	104	62.9	50.2	39.3	22.3	16.6	11.4
1.75V	162	127	99.9	61.1	48.1	38.5	21.5	15.8	11.2
1.80V	147	111	95.0	59.5	47.8	37.7	20.7	15.1	11.0

(Note)The above characteristics data are average values obtained within three charge/discharge cycles not the minimum values.

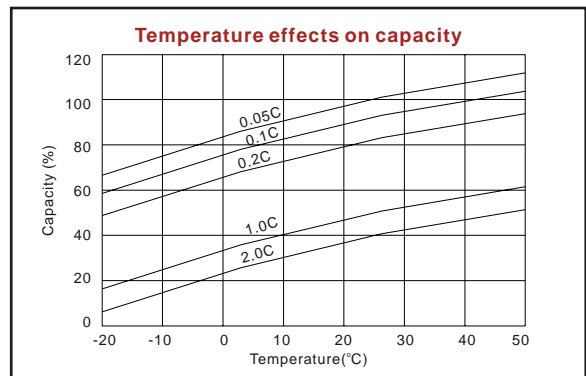
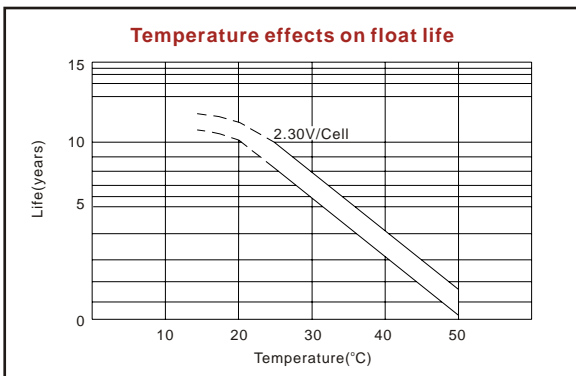
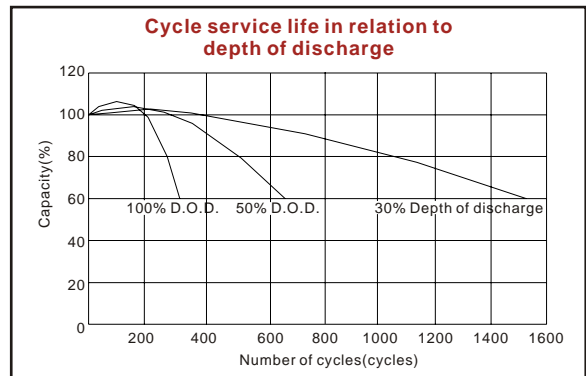
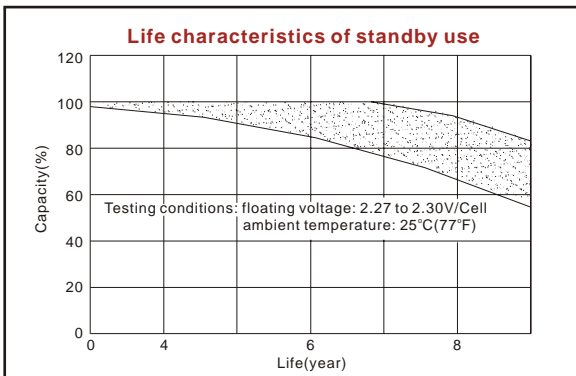
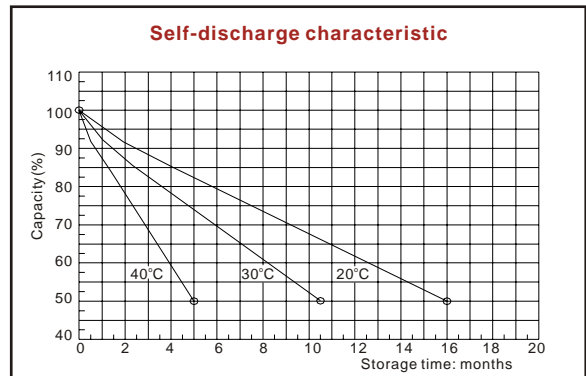
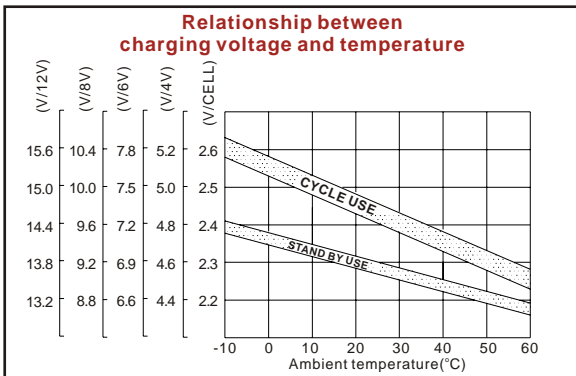
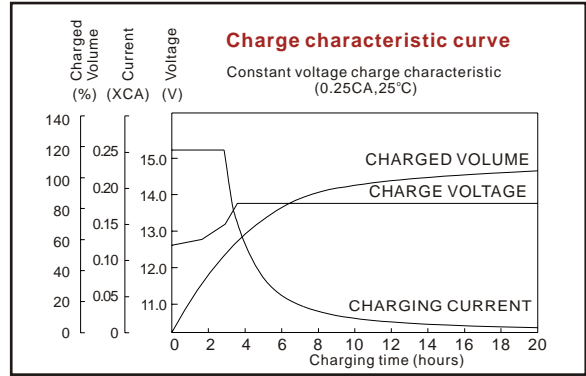
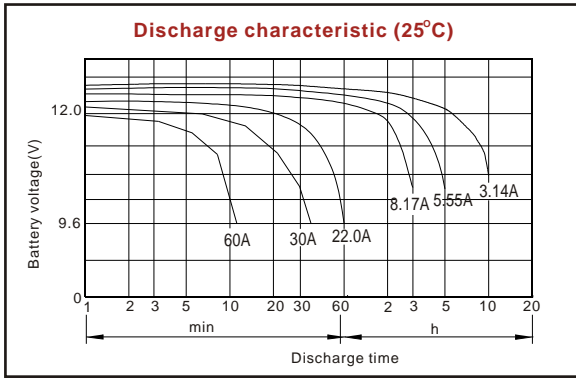

ISO9001:2000

MH25860

G4M19906-9202-E-16

www.vision-batt.com

Shenzhen Center Power Tech. Co., Ltd.
 Center Power Industrial Park, Tongfu Industrial District Dapeng Town, 518120 Shenzhen, China
 Tel: (+86-755) 8431 8088 Fax: (+86-755) 8431 8038 E-mail: sales@vision-batt.com